

IP65 IK07 CE 

TIPOLOGIA / TYPOLOGY

Paletto | Bollard

POSIZIONE INSTALLATIVA | INSTALLATION POSITION A terra | Ground mounting

AMBIENTE INSTALLATIVO | INSTALLATION LOCATION Esterno | Outdoor

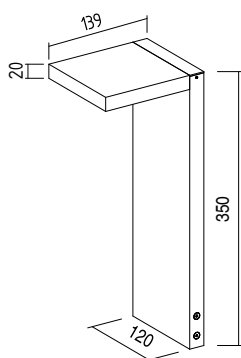
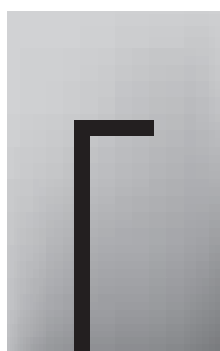

TEMISTO S

H 350 mm

9W

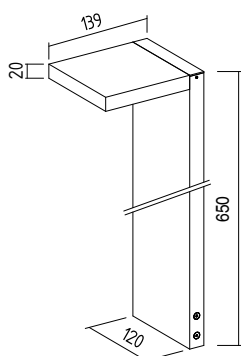
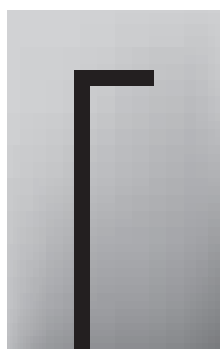
 kg 1,17

TEMISTO M

H 650 mm

9W

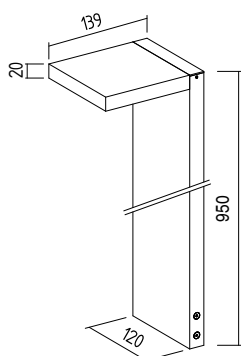
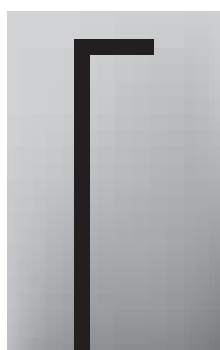
 kg 1,64

TEMISTO L

H 950 mm

9W

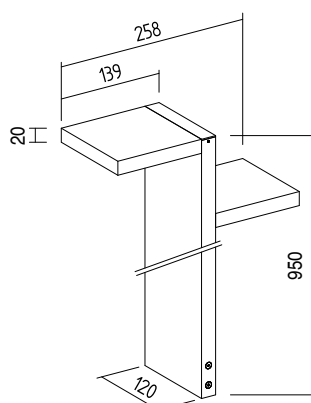
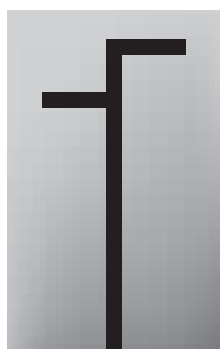
 kg 2,10

TEMISTO L - DOUBLE EM. H 950 mm

18W

 kg 2,56

TEMISTO

CARATTERISTICHE ELETTRICHE | ELECTRICAL FEATURES

POTENZA ASSORBITA | POWER CONSUMPTION S version: **9W** - M version: **9W** - L version: **9W** - L version double em.: **18W**

ALIMENTAZIONE | POWER SUPPLY **230Vac**

ALIMENTATORE | POWER SUPPLY UNIT **Integrato (con elettronica 230Vac) | Integrated (with 230Vac electronic)**

DIMMERAZIONE | DIMMING **Dimmerabile taglio di fase | Phase cut dimmable**

COLLEGAMENTO | CONNECTION **Tensione di rete | Mains voltage**

CARATTERISTICHE ILLUMINOTECNICHE | LIGHTING FEATURES

COLORE LED | LED COLOUR 2700K, 3000K, 4000K

INDICE RESA CROMATICA CRI | CRI **>90**

OTTICHE | OPTICS **Diffused**

FLUSSO TOTALE NOMINALE
TOTAL NOMINAL LUMENS

Single em.:	900lm (2700K)	990lm (3000K)	1080lm (4000K)
Double em.:	↓900+900↓lm (2700K)	↓990+990↓lm (3000K)	↓1080+1080↓lm (4000K)

DURATA MEDIA LED | AVERAGE LED LIFE **50.000h L80 B10**

CARATTERISTICHE MECCANICHE | MECHANICAL FEATURES

PESO | WEIGHT S version: **kg 1,17** - M version: **kg 1,64**
L version: **kg 2,10** - L version double em.: **kg 2,56**

FINITURE | FINISHES **Bianco txt, Grigio txt, Nero txt, Corten, Antracite txt**
txt White, txt Grey, txt Black, Corten, txt Anthracite

INSTALLAZIONE | INSTALLATION **A terra con basetta e viti incluse**
On ground with base and included screws

MATERIALE | MATERIAL **Corpo in alluminio anticorodal, basetta in acciaio inox AISI 304, diffusore in PMMA opalino**
Anticorodal aluminium body, AISI 304 stainless steel base, Opal PMMA diffuser

CARATTERISTICHE GENERALI | GENERAL FEATURES

TEMPERATURA DI ESERCIZIO
OPERATING TEMPERATURE **-10°C +45°C**

GRADO DI PROTEZIONE | INGRESS PROTECTION **IP65**

GRADO DI RESISTENZA | IMPACT RESISTANCE **IK07**

GLOW WIRE TEST | GLOW WIRE TEST **960°C.**

TEMPERATURA SCHERMO
SCREEN TEMPERATURE **40° @ Ta = 25°**

CLASSE DI ISOLAMENTO | APPLIANCE CLASS **I**

CALPESTABILE | WALKOVER **/**

CARRABILE | DRIVE OVER **/**

CAVI DI ALIMENTAZIONE | POWER CABLES **Fornito con 50 cm di cavo | Provided with 50 cm cable**

SICUREZZA STANDARD | STANDARD SAFETY **/**

SICUREZZA FOTOBIOLOGICA
PHOTOBIOLOGICAL SAFETY **GR1**